

TECHNICAL SPECIFICATIONS

Voltage:	12/24 Dual voltage with reverse polarity protection
LEDs:	33 x 5W Osram LEDs
Housing and Bracket:	Pressure die-cast aluminium housing and bracket
Beam Type:	Hybrid Beam Pattern
Lens:	Polycarbonate
Colour Temperature:	5700°K
Current draw:	13A at 12V

PARTS AVAILABLE

74403	Ultima LED Wiring Harness
72214BL	Ultima 215 LED – Lens Protector
72214BK	Ultima 215 LED – Lens Protector Black
74145	Ultima 215 LED – Metal Bezel (Black)
74146	Ultima 215 LED – Metal Bezel (Chrome)
74444	Ultima 215 LED – Adjustment Bolt
74444BK	Ultima 215 LED – Adjustment Bolt Black
74445	Ultima 215 LED – Bracket Kit

WARRANTY STATEMENT

Applicable only to product sold in Australia

Brown & Watson International Pty Ltd of 1500 Ferntree Gully Road, Knoxfield, Vic., telephone (03) 9730 6000, fax (03) 9730 6050, warrants that all products described in its current catalogue (save and except for all bulbs and lenses whether made of glass or some other substance) will under normal use and service be free of failures in material and workmanship for a period of one (1) year (unless this period has been extended as indicated elsewhere) from the date of the original purchase by the consumer as marked on the invoice. This warranty does not cover ordinary wear and tear, abuse, alteration of products or damage caused by the consumer.

To make a warranty claim the consumer must deliver the product at their cost to the original place of purchase or to any other place which may be nominated by either BWI or the retailer from where the product was bought in order that a warranty assessment may be performed. The consumer must also deliver the original invoice evidencing the date and place of purchase together with an explanation in writing as to the nature of the claim.

In the event that the claim is determined to be for a minor failure of the product then BWI reserves the right to repair or replace it at its discretion. In the event that a major failure is determined the consumer will be entitled to a replacement or a refund as well as compensation for any other reasonably foreseeable loss or damage.

This warranty is in addition to any other rights or remedies that the consumer may have under State or Federal legislation.

IMPORTANT NOTE

Our goods come with guarantees that cannot be excluded under the Australian Consumer Law. You are entitled to a replacement or refund for a major failure and compensation for any other reasonably foreseeable loss or damage. You are also entitled to have the goods repaired or replaced if the goods fail to be of acceptable quality and the failure does not amount to a major failure.

Distributed by:

**Brown & Watson
International Pty. Ltd.**
Knoxfield, Victoria 3180

www.narva.com.au

IS362 Issue 2 18.11.20

NARVA®

ULTIMA 215 L.E.D DRIVING LIGHT

Instructions & Specifications



IMPORTANT SAFETY INFORMATION

- Remove negative battery cable before installation.
- Ensure lamps are fitted using the appropriate wiring harness or an equivalent auxiliary wiring system.
We strongly recommend to use the Ultima LED Wiring Harness (74403)
- Ensure the lamps are mounted securely to a solid surface on the vehicle or bullbar.
- Cables connected to the lamp must not be subjected to wear or other damage.

MOUNTING

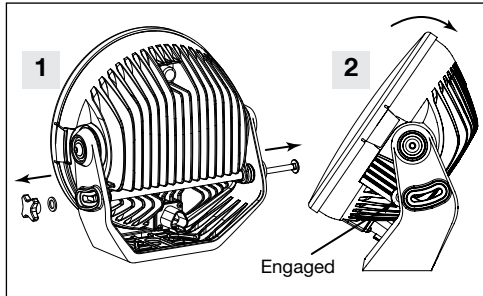

- 1 Remove Adjuster Knob, Flat Washer and Long Bolt.
- 2 Tilt lamp backwards to allow access to insert the mounting bolts (Ensure the lamp is still engaged with the bracket).
- 3 Place the mounting bolts through the holes in bracket. Note, 3 bolts are advised, if single bolt only, mount in centre hole.

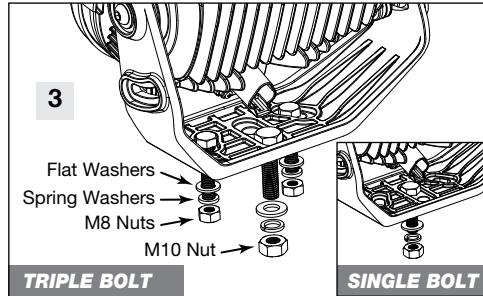

- 4 Re-assemble the Adjuster Knob, Flat Washer and Long Bolt in reverse order.
- 5 Choose a solid surface on the vehicle or bullbar to mount the driving lights and secure the lamp by using flat washers, spring washers with M10 & M8 nuts.
- 6 Ensure the Adjuster Knob is done up tight.

ASSEMBLIES

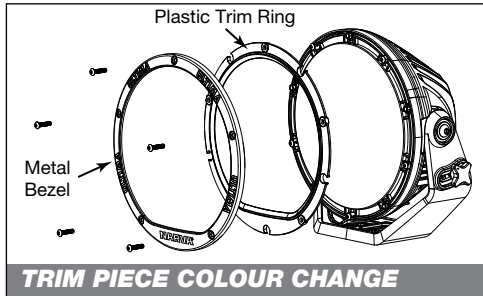

TRIM PIECE COLOUR CHANGE

To change the colour of the Plastic Trim Ring, remove 5 x screws and Metal Bezel. Re-assemble in reverse order.

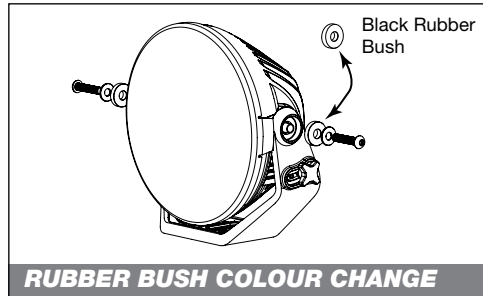

RUBBER BUSH COLOUR CHANGE

Remove the side M8 bolts, washers and blue rubber bushes. Replace with black rubber bushes. Re-assemble in reverse order.

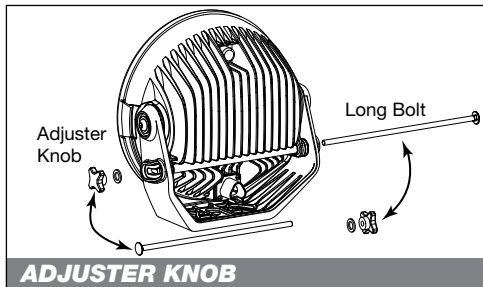

ADJUSTER KNOB

Adjuster Knob can be reversed from left hand to right hand side.

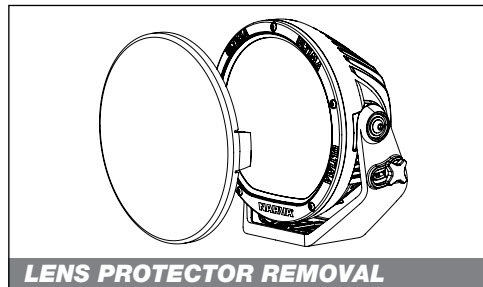

LENS PROTECTOR REMOVAL

Remove Lens Protector by un-clipping the side wings.

LAMP WIRING

ULTIMA L.E.D WIRING HARNESS

Part Number – 74403

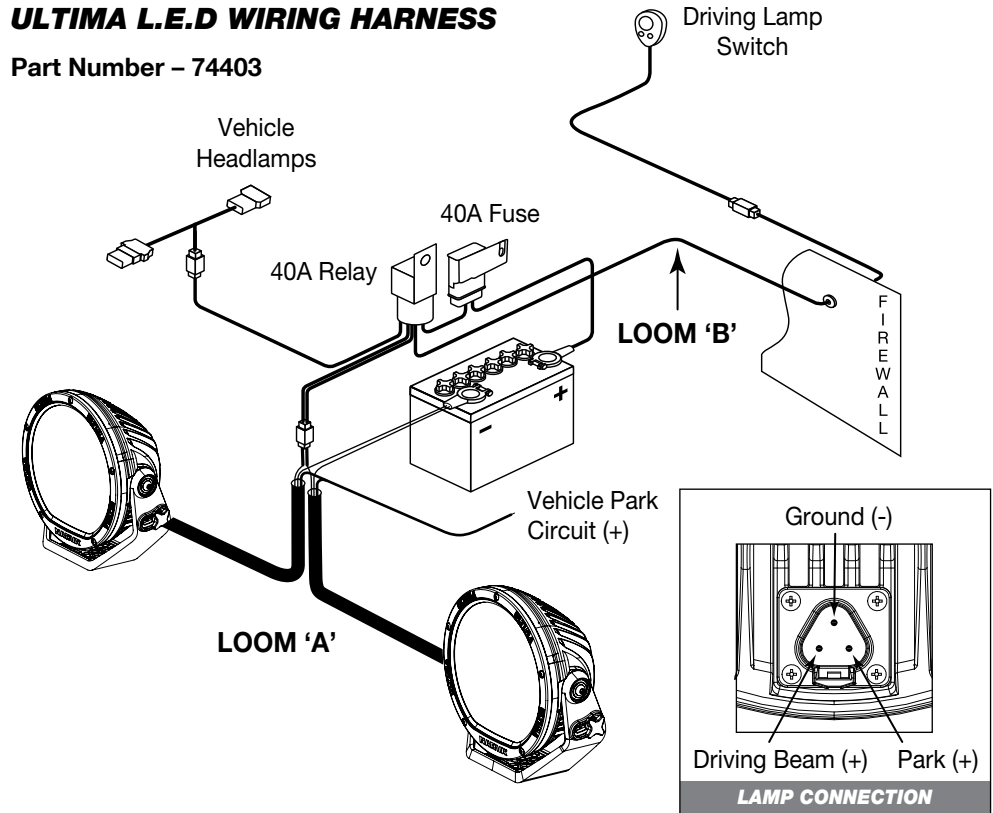

WIRING INSTRUCTIONS

- 1 Connect lamps to Loom 'A'.
- 2 Fix Loom 'A' ground cable to chassis or battery (-).
- 3 Connect Loom 'A' to Loom 'B'.
- 4 Mount relay and fuse holder (Ensure these are mounted in a dry area of the engine bay)
- 5 Connect main positive cable from fuse holder to battery (+).
- 6 The kit is supplied with a pre-wired H4 & HB3 loom assembly for direct connection to the vehicle headlamp high beam circuit. For globe types other than H4 & HB3, an additional adapter kit (P/No. 74416) is available to suit H1, H3 and H7 globe types.
- 7 A direct connection from the vehicle high beam circuit to any alternate light source can be made by connecting the black wire to negative and red wire to positive.
- 8 Connect Loom 'A' brown cable to vehicle park circuit (+).
- 9 Pass Loom 'B' through the firewall and connect to Driving Lamp Switch.
- 10 Test the driving lights by turning on the vehicle's headlamps and park light. The driving lights should only illuminate on high beam.

Note: Driving lights must dip with H/Beam to meet ADR requirements